

START-SET: PERSONENZUG DAMPFLOK + 2 PERSONENWAGEN # 37130/38130

Passenger Train Starter Set · Coffret de départ train à voyageurs · Startset Lokale trein

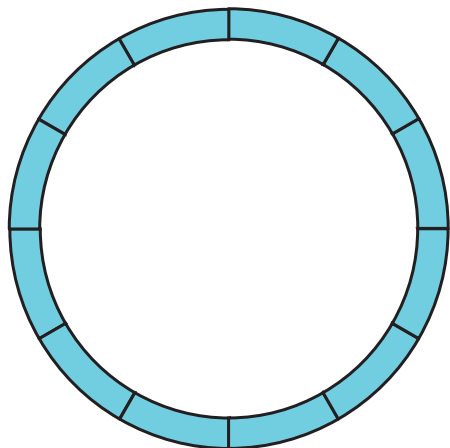

Empfohlene Aufbaufläche
Recommended area of layout
Surface minimale de montage
Minimale opbouwoppervlakte:
ca. 140 x 140 cm

Grundfläche
ground area
Surface utilisée
Grondoppervlakte:
ca. 120 x 120 cm

- 1 x Dampflokomotive
- 2 x Personenwagen
- 12 x 35211 R1 (Bogen 600 mm)
- 1 x 35270 Anschlussklemme
- 1 x 35285 Verbindungsclip (14 St.)
- 1 x Fahrregler
- 1 x Netzteil
- 1 x 36039 Handentkuppler

- 1 x Loco vapeur
- 2 x Wagons à voyageurs
- 12 x 35211 Rail courbes R1, r = 600 mm
- 1 x 35270 Fiches des connexion
- 1 x 35285 Clips de rail (14 ps.)
- 1 x Régulateur de vitesse
- 1 x Bloc d'alimentation
- 1 x 36039 Système d'attelage

- 1 x Steam Locomotive
- 2 x Passenger Cars
- 12 x 35211 Curved Track R1, r = 600 mm
- 1 x 35270 Power Clamps
- 1 x 35285 Track Clips (14 pcs.)
- 1 x Speed control
- 1 x Safety-approved Transformer
- 1 x 36039 Uncoupling Wand

- 1 x Locomotief
- 2 x Rujitwagens
- 12 x 35211 Gebogen railstuk R1, r = 600 mm
- 1 x 35270 Aansluitclips
- 1 x 35285 Railverbindingsclip (14 stuks)
- 1 x Snelheidsregelaar
- 1 x Netadapter
- 1 x 36039 Ontkoppelgereedschap



Technische und farbliche Änderungen vorbehalten. Maße und Abbildungen sind freibleibend. Alle Angaben erfolgen ohne Gewähr.
All information subject to change without notice.
Informations susceptibles de modification.

Wijzigingen in kleurstelling, technische gegevens, maten en afbeeldingen zijn onder voorbehoud.
37130-90-7011

0-24 V



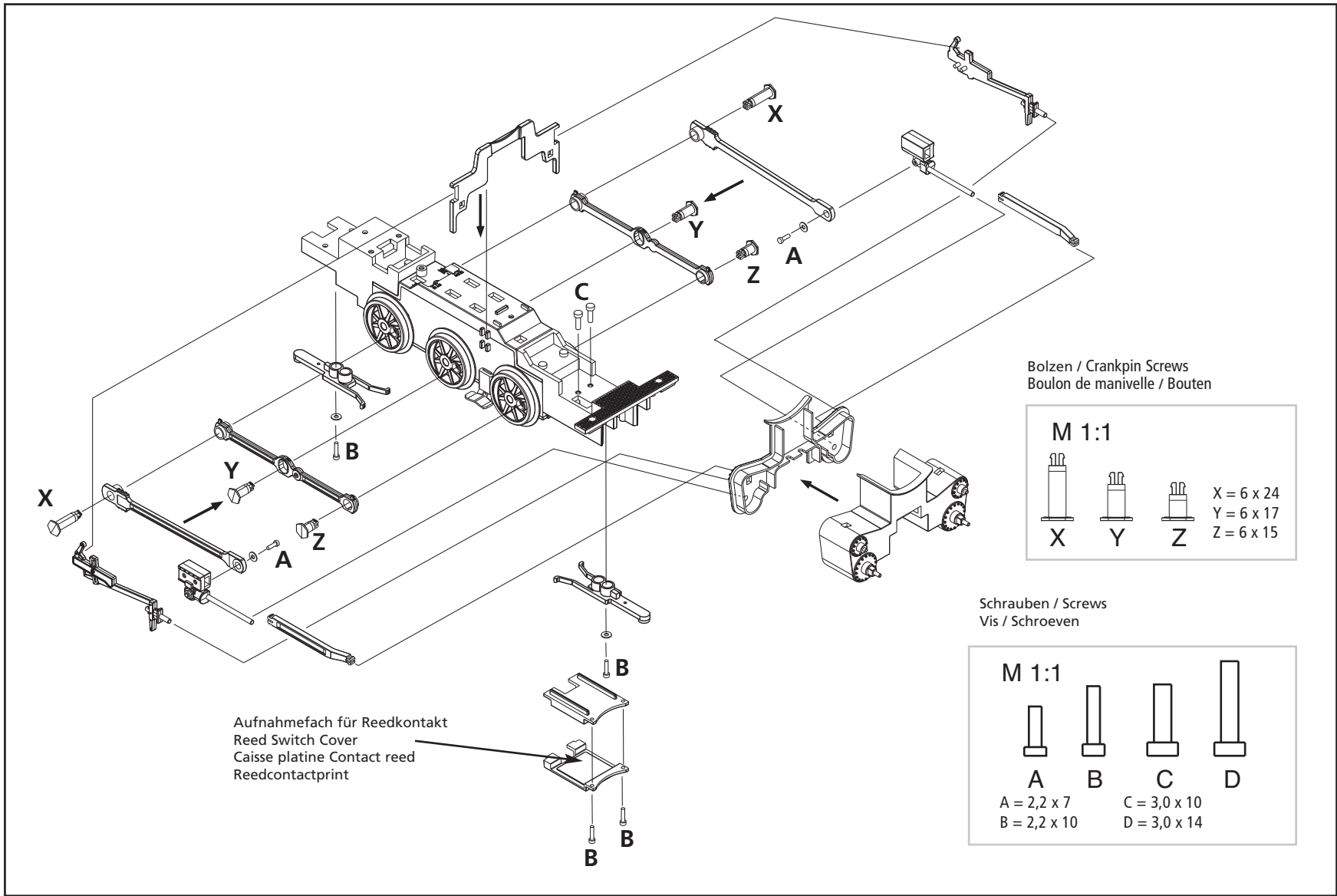

Bolzen / Crankpin Screws
 Boulon de manivelle / Bouten

M 1:1

X = 6 x 24
 Y = 6 x 17
 Z = 6 x 15

Schrauben / Screws
 Vis / Schroeven

M 1:1

A = 2,2 x 7
 B = 2,2 x 10
 C = 3,0 x 10
 D = 3,0 x 14

Aufnahmefach für Reedkontakt
 Reed Switch Cover
 Caisse platine Contact reed
 Reedcontactprint

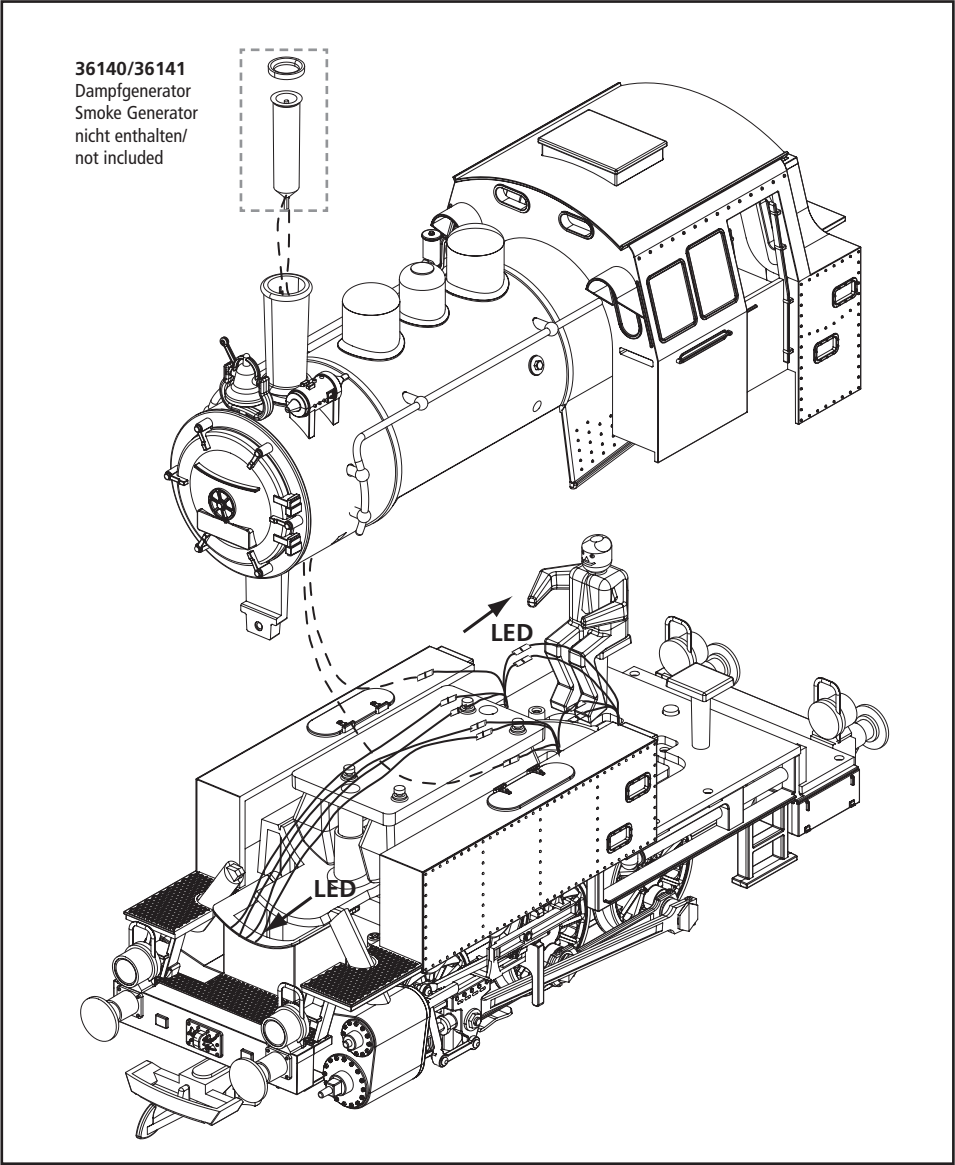
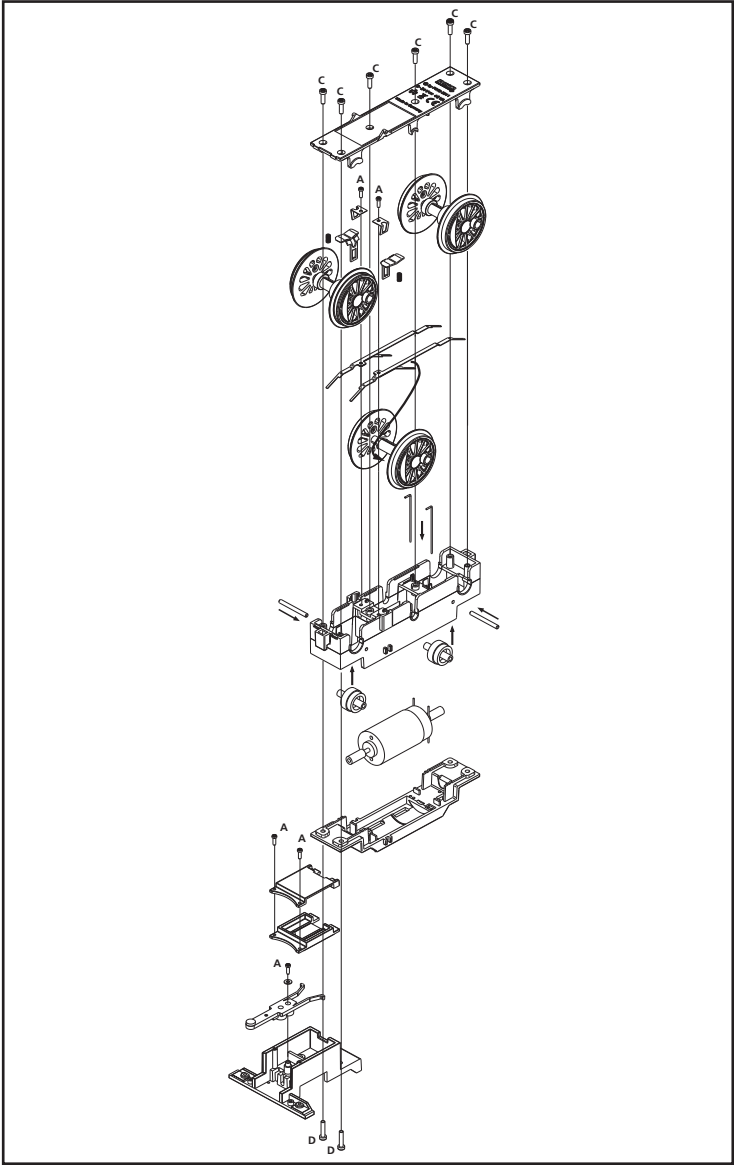

VERDRAHTUNGSSHEMA

Wiring scheme · Schema de câblage · Bedradingsschema

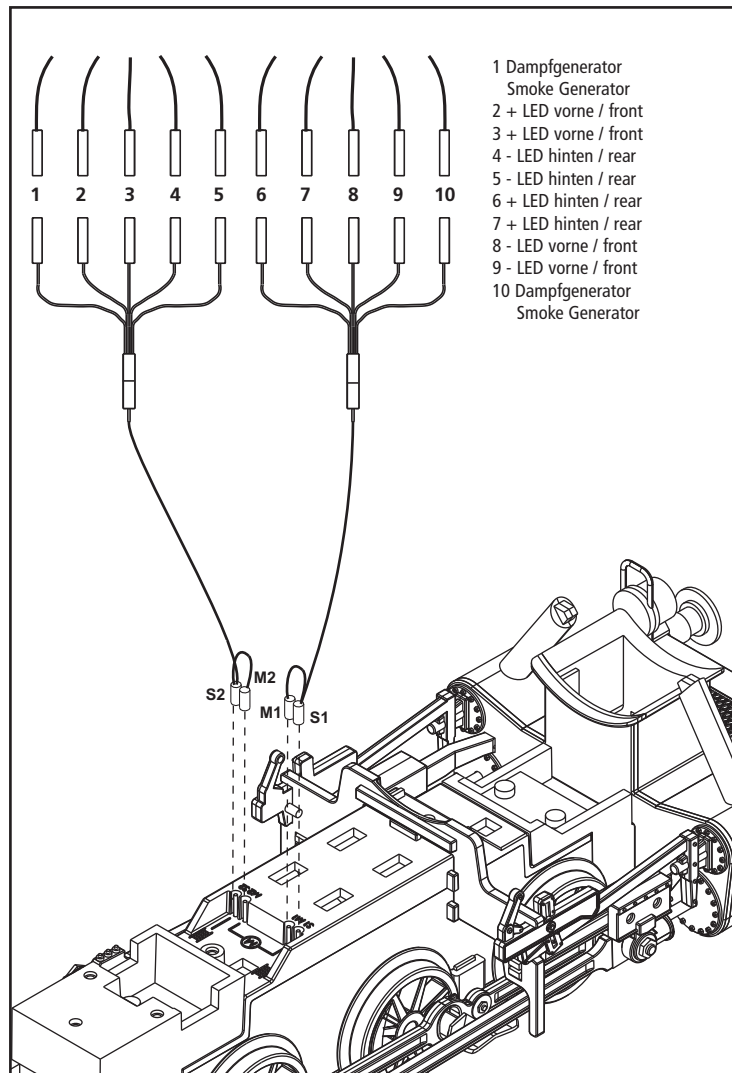

HANDENTKUPPLER

Uncoupling Wand · Système d'attelage · Ontkoppelgereedschap

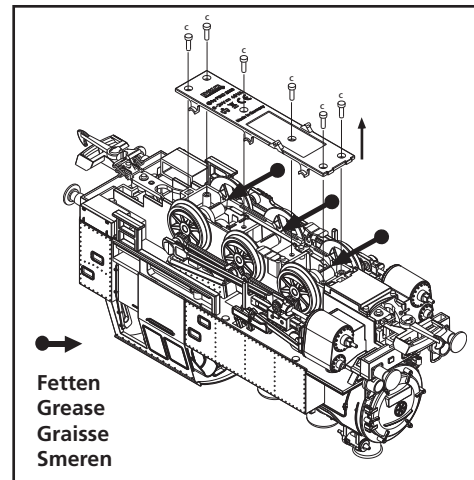

ERSATZTEILE DAMPFLOK

Spare parts · Pièces détachées · Reserveonderdelen

Bei Ersatzteilanforderung bitte immer die vollständige Ersatzteil-Nr. angeben. · Please order the wanted spare part with the complete spare part item number. · Lorsque vous commandez une pièce, veuillez bien nous donner la référence complète de la pièce. · Bij bestelling van een reserveonderdeel svp altijd het volledige onderdeelnummer opgeven.

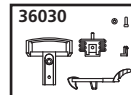
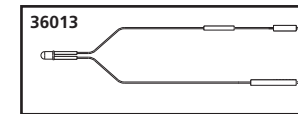
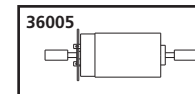
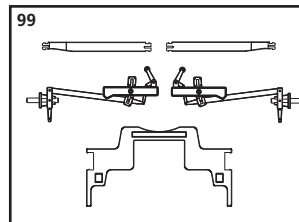
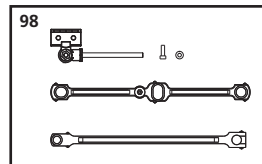
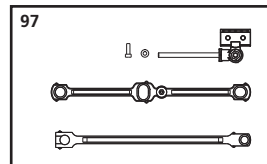
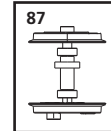
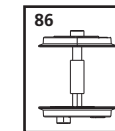
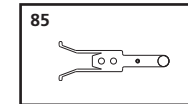
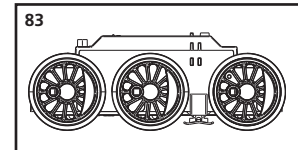
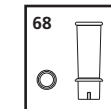
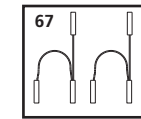
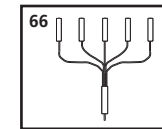
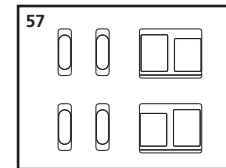
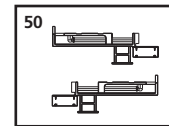
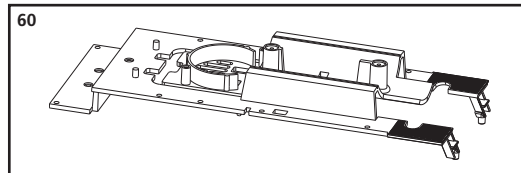
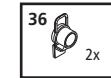
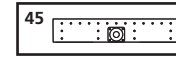
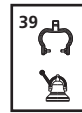
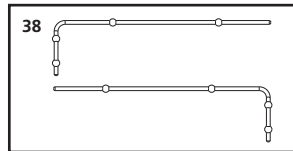
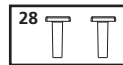
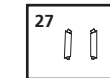
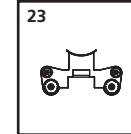
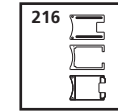
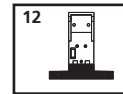
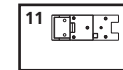
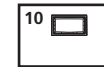
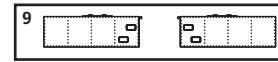
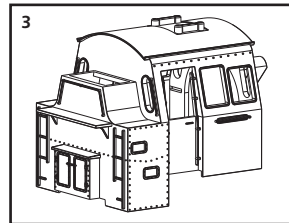
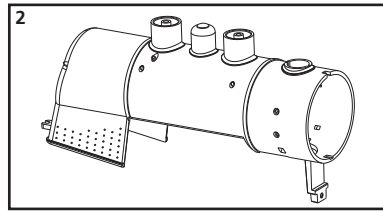

36090
 A = 2,2 x 7
 B = 2,2 x 10
 C = 3,0 x 10
 D = 3,0 x 14
 E = 3,0 x 6

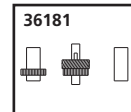
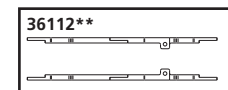
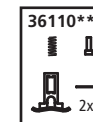

ERSATZTEILLISTE DAMPFLOK

Spare parts · Pièces détachées · Reserveonderdelen

Nr:	Bezeichnung:	Description:	Désignation:	Beschrijving:	PG*
37130A-02	Kessel	Boiler	Chaudière	Ketel	11
37130A-03	Führerhaus	Cab with Fuel Bunker	Cabine	Machinistenhuis	11
37100A-08	Dachabdeckung	Roof Hatch Cover	Clapet de toit	Ontluchtungsluik	6
37130A-09	Wasserkästen	Water Tanks	Réservoir à eau	Waterkasten	12
37100A-10	Kohleaufsatz	Coal Insert	Charbon	Kolenbak	6
37100A-11	Rahmenhinterteil	Rear Sub-Frame	Partie arrière du chassis	Chassisdeel achterzijde	8
37100A-12	Rahmenvorderteil	Front Sub-Frame	Partie avant du chassis	Chassisdeel voorzijde	9
37130A-14	Puffer (2 St.)	Buffers, 2Pcs	Tampons (2 unités)	Buffer (2 stuks)	6
37130A-216	Gehäuse Reedkontaktplatine	Reed Switch Housing	Caisse platine contact reed	Behuizing voor de Reedcontactprint	8
37100A-23	Zylinder	Cylinder Saddle	Cylindre	Cylinder	9
37130A-25	Revisionsdeckel	Smokebox Inspection Plug	Couvercle de visite	Wasluik	6
37100A-27	Dampfrohr (2 St.)	Steam Pipe, 2 Pcs	Tuyaux vapeur x 2	Stoomleiding (2 st.)	7
37100A-28	Sitz (2 St.)	Seat, 2 Pcs	Siège (2 unités)	Machinistenstoel (2 stuks)	8
37130A-30	Rauchkammertür	Smokebox Front	Porte de boîte à fumée	Rookkastdeur	9
37100A-33	Lichtmaschine	Turbo Generator	Appareil lumineux	Dynamo	6
30101-34	Abdeckkappe Dom (2 St.)	Dome Covers, 2 Pcs	Dessus dôme tender (2 unités)	Afdekking voor dom (2 stuks)	7
37200-36	Laterne mit Linse (2 St.)	Lantern with Linse, 2 Pcs	Phares (x2)	Lantaarns met glas (2 stuks)	11
37130A-38	Handstangen Kessel (2 St.)	Handrails, Boiler (2 Pcs)	Poignées (2 unités)	Handgrepen, ketel (2 stuks)	7
37130A-39	Glocke mit Glockenhalter	Bell Bracket and Bell	Cloche avec support	Bel met houder	8
37410-42	Winkelkontakte Antriebseinheit (2-tlg.)	Gearbox Contact Posts, 2 Pcs	Equerres pour fixation moteur (2 pièces)	Hoekcontacten aandrijfkast (2-delig)	5
37130A-43	Dampfpfeife	Whistle	Sifflet	Stoomfluit	7
37100A-44	Pufferbohle (für 2 Puffer)	End Beam for 2 Buffers	Traverse de tamponnement + 2 tampons	Bufferbalk met 2 buffers	9
37100A-45	Pufferbohle (für Mittelpuffer)	End Beam for Single Buffer	Traverse de tamponnement + tampon central	Bufferbalk met middenbuffer	9
37100A-48	Luftkessel (2 Stück)	Air Cylinder, 2 Pcs	Citernes à air x 2	Luchtketel (2 st.)	7
37100A-50	Rahmenseitenteile (2-tlg.)	Cab Floor Side Frame, L & R	Parties latérales du chassis x 2	Chassis zijdelen (2-delig)	9
37100A-57	Satz Fenster	Window Inserts (Set of 6)	Fenêtres	Venster	10
37130A-60	Bodenplatte	Main Frame	Support	Bodemplaat	12
37100A-66	Verteilerkabel	Wiring Harness	Câble de répartition	Verdeelkabel	7
37100A-67	Motorkabel (2 St.)	Cables (Set of 2)	Câble (2 unités)	Motorkabel (2 st.)	9
37130A-68	Schornstein lang	Smokestack long	Cheminée	Schoorsteen	8
37130A-82	Kurbelbolzen (6-tlg.)	Crankpin Screws (Set of 6)	Boulon de manivelle (6 unités)	Bouten (6-delig)	8
37130A-83	Getriebe	Gear box, Complete	Engrenage, complet	Aandrijving, compleet	23
37100A-85	Kupplungsarm	Coupler Arm	Attelage	Koppelaar	6
37130A-86	Radsatz ohne Zahnrad	Wheelset without Gear	Essieux	Wielstel	12
37130A-87	Radsatz mit Zahnrad	Wheelset with Gear	Essieux avec pignon	Wielstel met tandwiel	13
37320-93	Zahnradwelle	Idler Gear shaft	Lame	Tandwielas	7
37130A-97	Steuerungsteile links	Valve Gear parts left	Embiillage gauche	Linke Drijfwerk delen	10
37130A-98	Steuerungsteile rechts	Valve Gear parts right	Embiillage droit	Rechte Drijfwerk delen	10
37130A-99	Steuerung 2	Valve Gear 2	Embiillage 2	Drijfwerk 2	10
	Standard Ersatzteile	Catalog Parts	Pièces détachées standard	Standaardonderdelen	
36005	Motor mit Schnecken	Motor w/ Gears	Moteur avec mandrin	Motor met wormwiel	
36013	LED Beleuchtung	LED Lighting	Led	LEDs	
36030	Kupplung komplett	Standard Loco Coupler	Attelage, complet	Koppeling, volledig	
36090	Schrauben-Set (20-tlg./5 Größen)	Set of screws (20 pieces / 5 sizes)	Jeu de vis	Set schroeven	
36110**	Schienenfleifer (2 Sets)	Pick-Up Shoes, 2 Pieces	Contact de rails (2 unités)	Railsleepcontact (2 sets)	
36112**	Radsatzkontakt re. + li.	Wheel Wipers, R & L	Contacts d'essieux (droit & gauche)	Wielcontact rechts en links	
36181	Zahnradset	Gear Set	Roues dentées	Tandwielset	
36200	Lokführer bemalt	Engineer Figure	Conducteur de locomotive	Machinistenfiguur	

* Preisgruppe · price category · catégorie de prix · Priscategorie

** Verschleißteil · Wearing part · Pièce de fatigue

ZUBEHÖR BR 80 Accessories · Accessoires

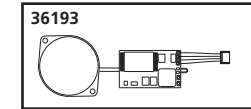
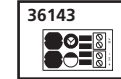
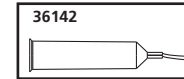
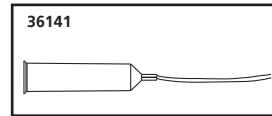
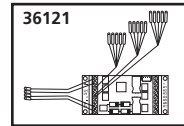
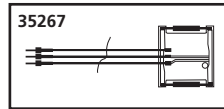
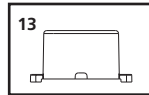

Nr:	Zubehör	Optional Add-Ons	Accessoires	Accessoires	PG*
35267	Reedkontaktschalter	Reed Switch Assembly	Contact Reed	Reedcontact	
36121	Digital Decoder	Decoder	Décodeur	Digitale decoder	
36141	Dampfgenerator digital	Smoke Generator for Digital	Générateur de fumée, digital	Rookgenerator digitaal	
36142	Dampfgenerator 5 V	Smoke Generator 5 V	Générateur de fumée, 5 V	Rookgenerator 5 V	
36143	Festspannungsregler 5 V	Voltage Regulator 5 V	Régulateur de tension 5 V	Spanningsregelaar 5 V	
36193	Sound-Modul BR 80	BR 80 Steam Sound Kit	Module de son BR 80	Soundmodule BR 80	
36210	Dampföl 250 ml	Smoke and Cleaning Fluid, 250 ml	Liquid Fumigene, 250 ml	Rookvloeistof, 250 ml	
38100A-13	Schallkapsel für Lautsprecher	Speaker Enclosure	Caisse de résonance pour haut parleur	Geluidskast voor luidspreker	6

ERSATZTEILE PERSONENWAGEN

Spare parts Passenger Cars · Pièces détachées Wagon à voyageurs · Reserveonderdelen Rujitwagens

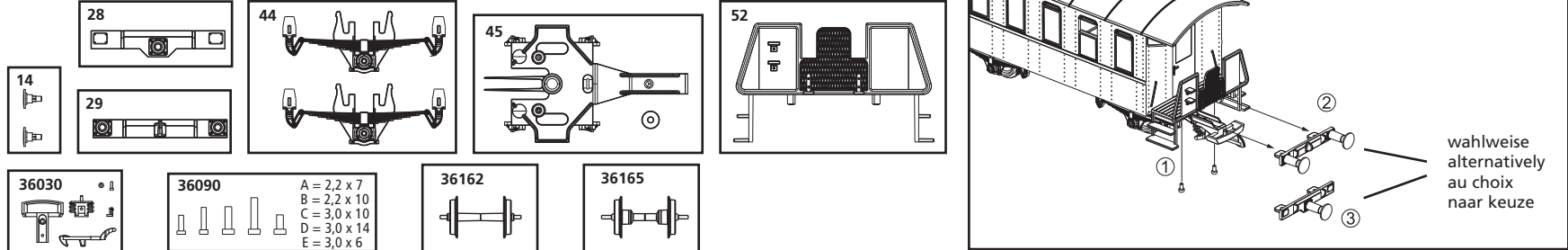

Nr:	Bezeichnung:	Description:	Désignation:	Beschrijving:	PG*
37600-28	Pufferbohle für Mittelpuffer	End Beam for central buffer	Traverse de tamponnement (tampon central)	Bufferbalk (middenbuffer)	8
37600-29	Pufferbohle für 2 Puffer	End Beam for 2 buffers	Traverse de tamponnement (2 tampons)	Bufferbalk (2 buffers)	8
37500-14	Puffer (2 St.)	Buffers (set of 2)	Tampons (2 unités)	Buffer (2 stuks)	6
37900-44	Radblenden	Truck Sideframes	Flasques à bogies	Wielplaten	10
37900-45	Achshalter	Main Truck Frame	Support d'essieux	Aslager	10
37920-52	Bühne	Plattform	Plateforme	Platform	10
36030	Kupplung komplett	Standard Coupler	Pièces détachées standard Attelage, complet	Standaardonderdelen Koppeling, volledig	
36090	Schrauben-Set (20-tlg./5 Größen)	Set of screws (20 pieces / 5 sizes)	Jeu de vis (20 pièces, 5 tailles)	Set schroeven (20-delig)	
36162	Radsatz Kunststoff 3 St.	Plastic wheel set (set of 3)	Essieux plastiques (3 unités)	Kunststof wielstel (3-delig)	
36165	Radsatz Metall (2 St.)	Metal wheel set (set of 2)	Essieux métalliques (2 unités)	Metalen wielstel (2-delig)	

*Preisgruppe *price category *catégorie de prix *Priscategorie